



AI for HealthCare

From research and innovation to implementation

Claudine Lamothe (UMCG)
Ronald Hesse (Triade)

De AI-hub Noord-Nederland wordt mede mogelijk gemaakt door de subsidiepartners:



Applications of AI for Health: A trend shift

- From a reactive to a proactive (prevention) healthcare system
- Faster , better, predictive diagnoses
- Personalised treatments
- Predict health progression & treatment impacts at a collective level (cohorts) and at the individual level (personalised care)
- Support better self-management of chronic patients
-

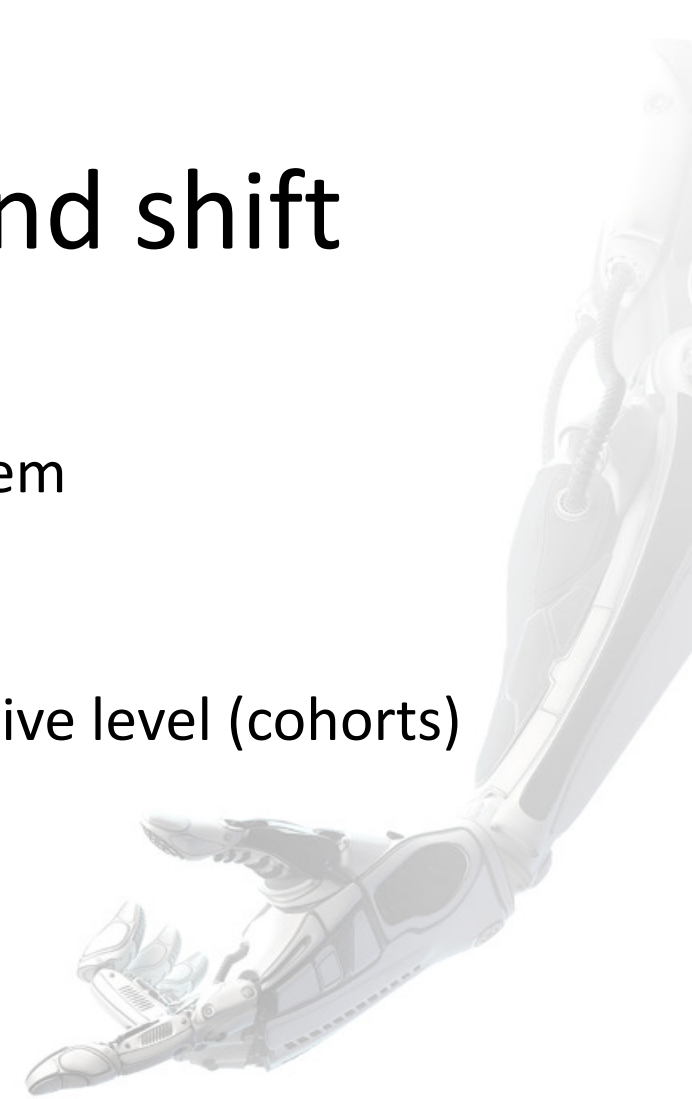

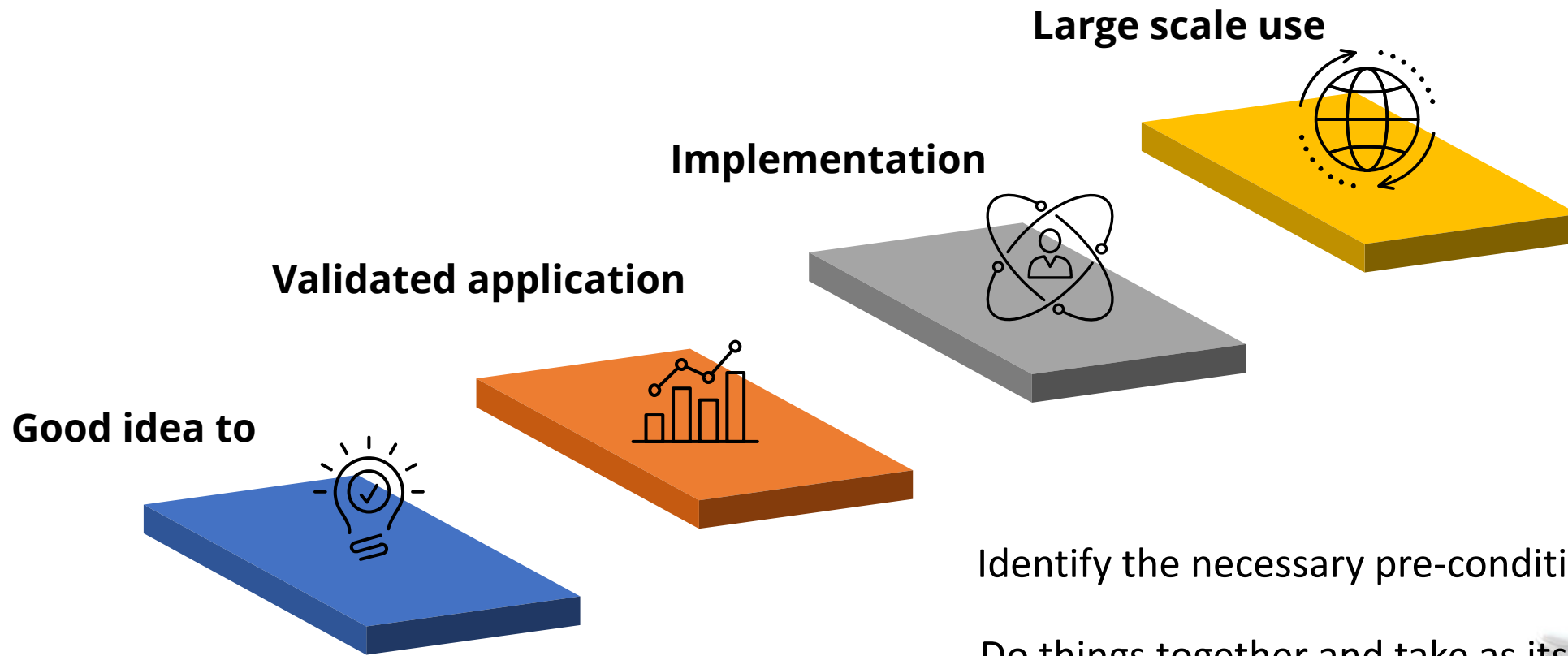

Identify the necessary pre-conditions to implement AI

Do things together and take as its starting point the value AI brings to our society

Emphasis action and impact.

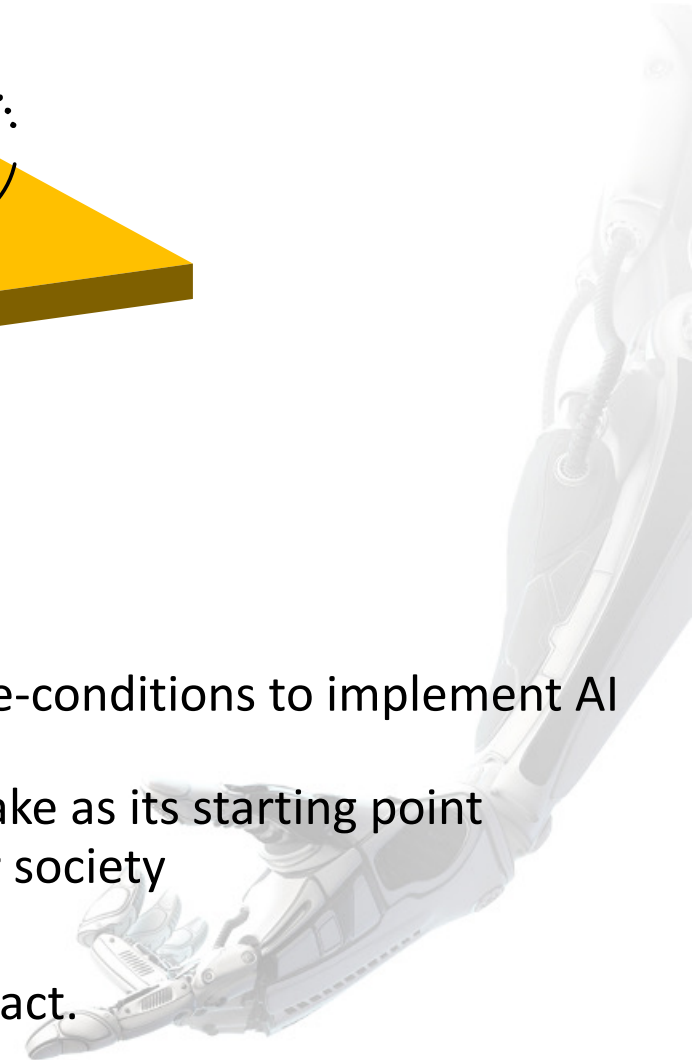

Interactive break-out session

- During this interactive break-out session, experiences and challenges towards implementation will be discussed
 - from the perspective of four experienced entrepreneurs
 - Audience
- Two 'use-cases' examples



Healthy living as a service

Realize healthy lifestyle, supported by technology and Artificial Intelligence (AI)-healthy living services

Collaboration across domains, citizens, scientists, technology, healthcare, artists, business and industry

The results will be citizens that have ownership over their health by:

- health, technology and data literacy;
- healthy and involved communities;
- a monitoring system with wearables and nearables;
- motivational feedback and coaching supported by an AI-based Decision Support System



KIC #13948 Leefstijl & Leefomgeving



Predictive Diagnostics



The **Life Cooperative** is a Northern Netherlands-based SME association (coöperatie u.a.) with **45 member-businesses** in the Life Sciences and Health sector, generating over € 500 million turnover with close to 4.500 employees.

Its aim is to facilitate **next generation innovation** by and between member-companies, together with knowledge and health institutes in the region.

www.lifecooperative.nl

Predictive Diagnostics (2023-2027)

Predictive Diagnostics is a platform for innovation and implementation of AI in Healthcare, serving innovators (TRL 3-8) by providing access to all relevant expertise, facilities, funds and talent in the region. It operates like a **business-run** platform focused on effective, personalized service delivery: from scouting & intake, screening and advice, to business case building and servicing, demonstrations and piloting, and finally (scale-up) investor readiness and intro.



Scout 100+ leads



accept 40 into the program



generate 10+ investable BC's

To get there, the platform needs to build competences and track-record, as well as a comprehensive infrastructure (network, collaborations and additional services and facilities).

Total budget will be around € 8M



Chandler Hatton
CTO



ZIUS.
visual intelligence



Real-world applications for AI & computer vision

Forensic Investigations



Pharmacy Automation



Medical Imaging

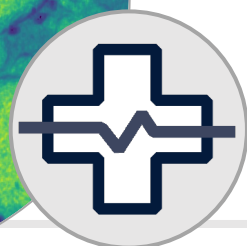
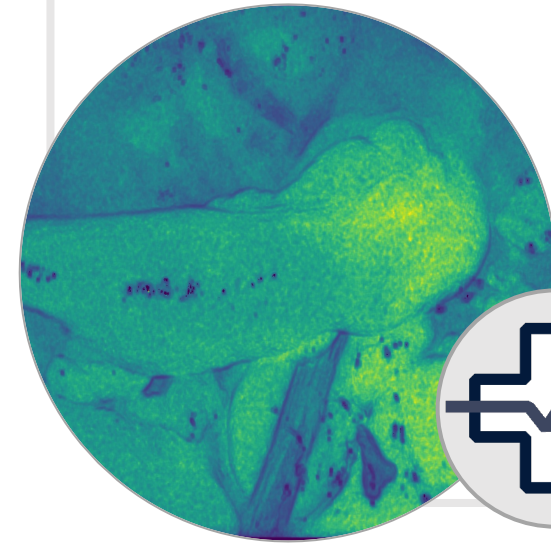



ZiuZ Forensic Investigations

VizX2

2nd generation,
first product
launch 2006



Market leader in products and services that **analyze huge amounts of visual data** to fight sexual abuse of children, used in 50+ countries worldwide

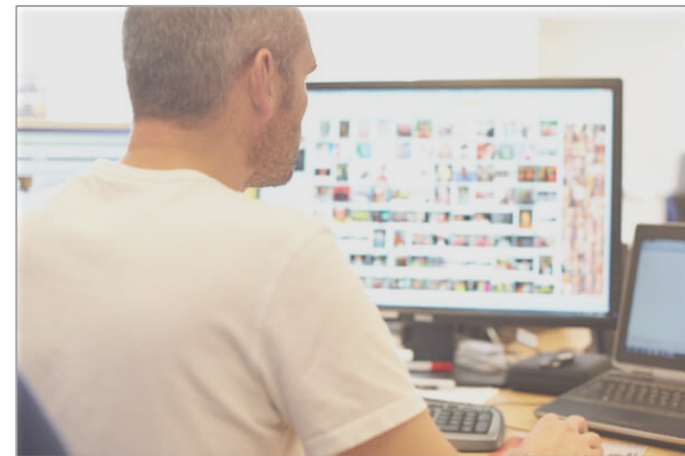
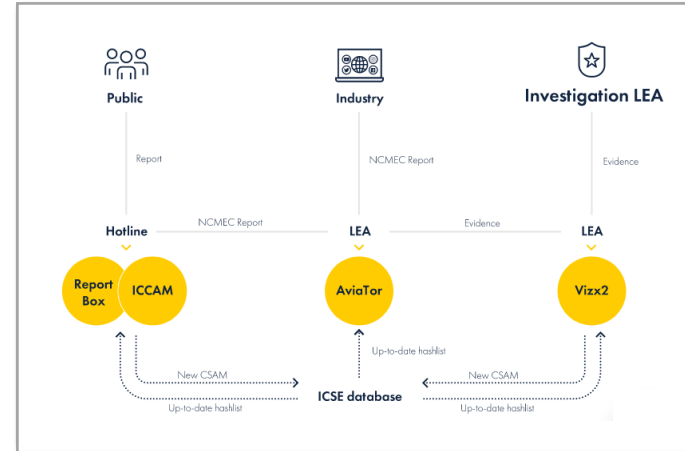



ZiuZ Pharmacy Automation

ApolloZ

3rd generation,
first product
launch 2009

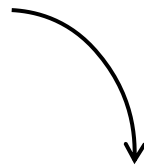

Market leader in
automated visual checking
of medicine pouches,
checking **12 million pouches**
in 17 countries each day





ZiuZ Medical Imaging & LIMIS

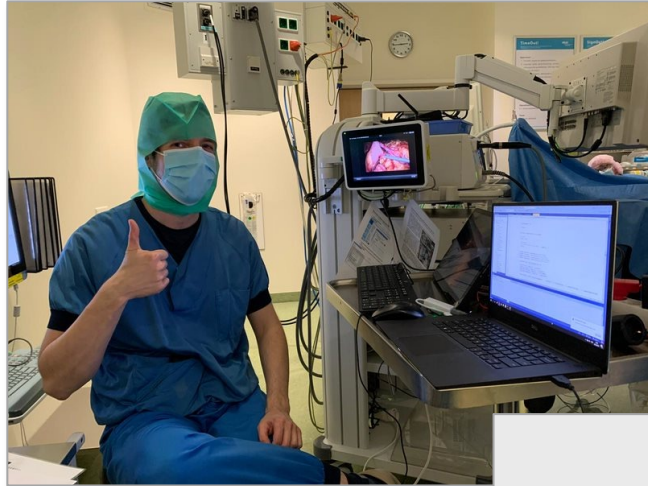

A medical device that offers surgeons a **real-time** heatmap of microvascular **blood flow** using **laser speckle contrast imaging**

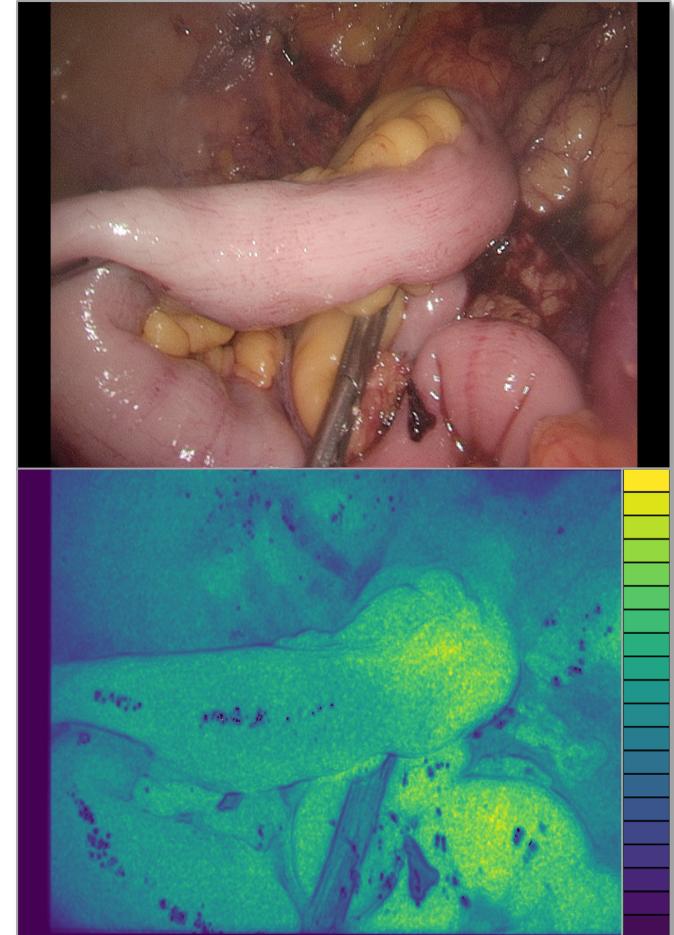

PerfusiX-Imaging

First product
launch 2023



ALESSANDRO GRILLINI, PhD, CEO/CTO

- Background in Computer Science, Psychophysics, Computational Neuroscience
- Solo founded Reperio Medtech in 2020
- CEO/CTO, team of 6
- From “idea in the lab” to “product on the market”



REPERIO MEDTECH

Objectify neuro-visual diagnostics with Eye-Tracking and Deep Learning

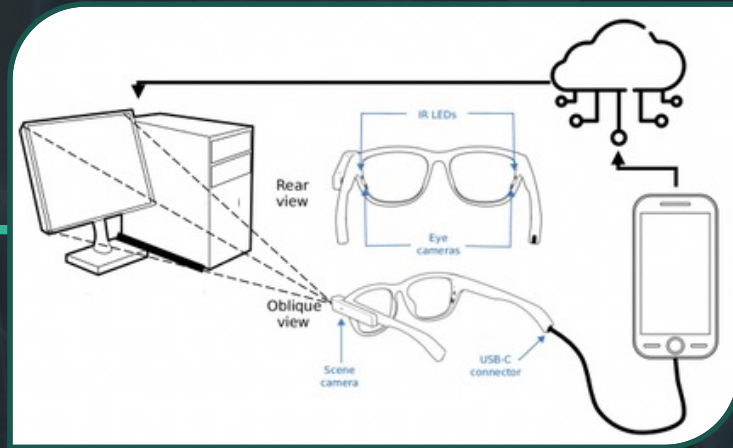
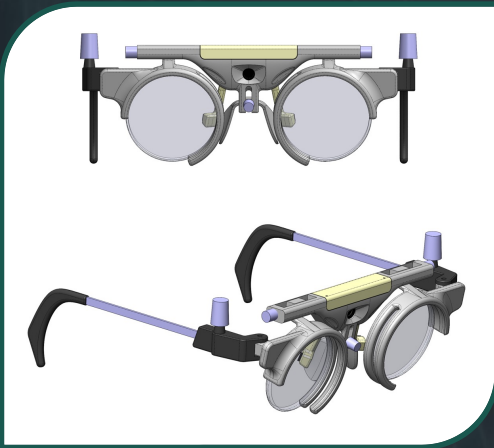

AI

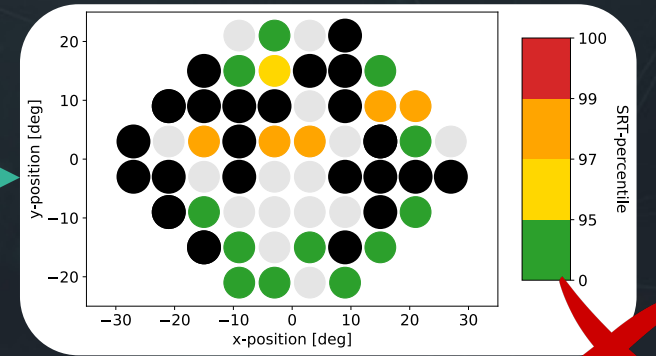
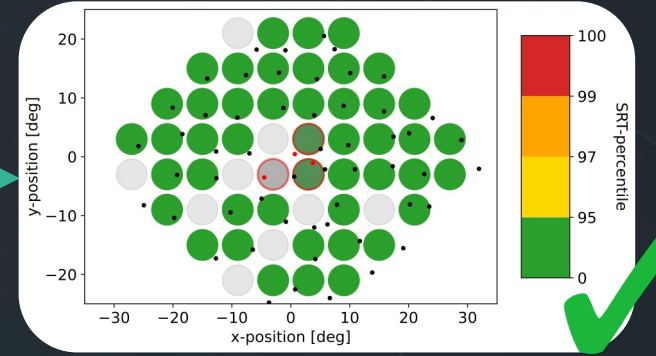

Accurate & Objective



Patient-Friendly & Portable



80% Faster than current methods

Algorithm development

CE certification

1

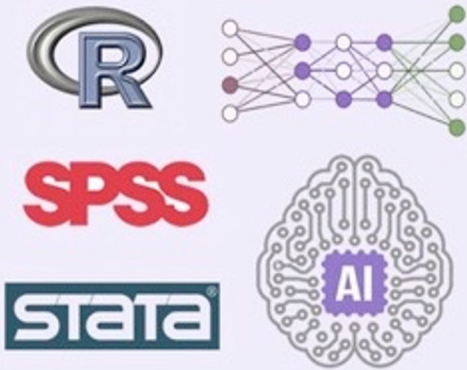

EVIDENCIO



3



Algorithm validation

Algorithm integration

2



4

$$P = \frac{e^{(\beta + \alpha_1 X_1 + \dots + \alpha_n X_n)}}{1 + e^{(\beta + \alpha_1 X_1 + \dots + \alpha_n X_n)}}$$

More info? Please send an e-mail to r.g.pleijhuis@evidencio.com or visit www.evidencio.com

Standardized algorithm creation

Evidencio offers tools for researchers to create functional prediction algorithms in a standardized manner.

Settings Variables Formula segments RScript

Calculation method

Linear model
Logistic regression
Cox regression
Custom model
RScript
External API

Input type

Custom variables

Calculation (More info)
Insert your own R script

Model variable type ⓘ

Standard model	UMLS model
----------------	-------------------

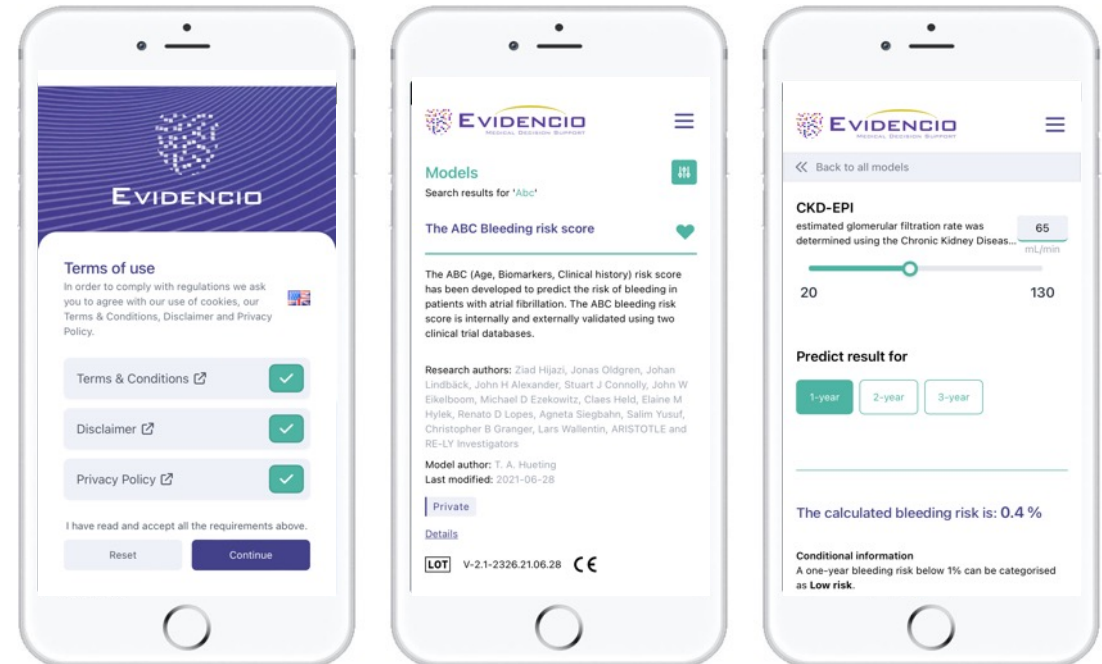
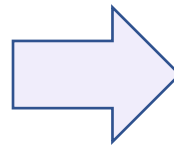

Compliance with European law (MDR)

Evidencio enables cost-effective and time-efficient CE-certification of (pooled) prediction algorithms through:

- Standardization
- Established QMS
- Reuse of platform components



EUROPEAN
COMMISSION



Traditional Healthcare: co-location of patient, doctor, diagnostic procedures and data

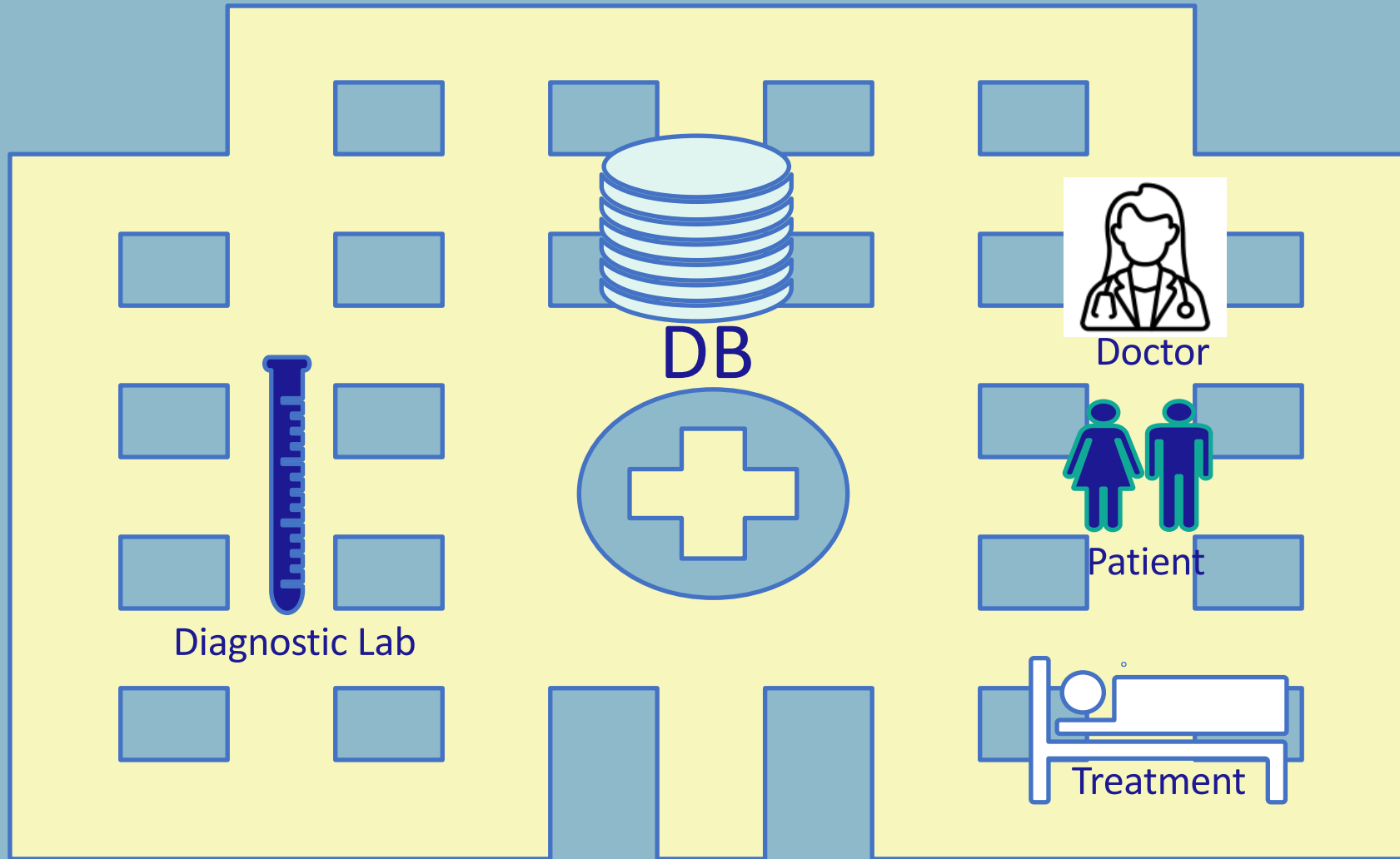

The rise of Distributed Healthcare (DH) including AI:

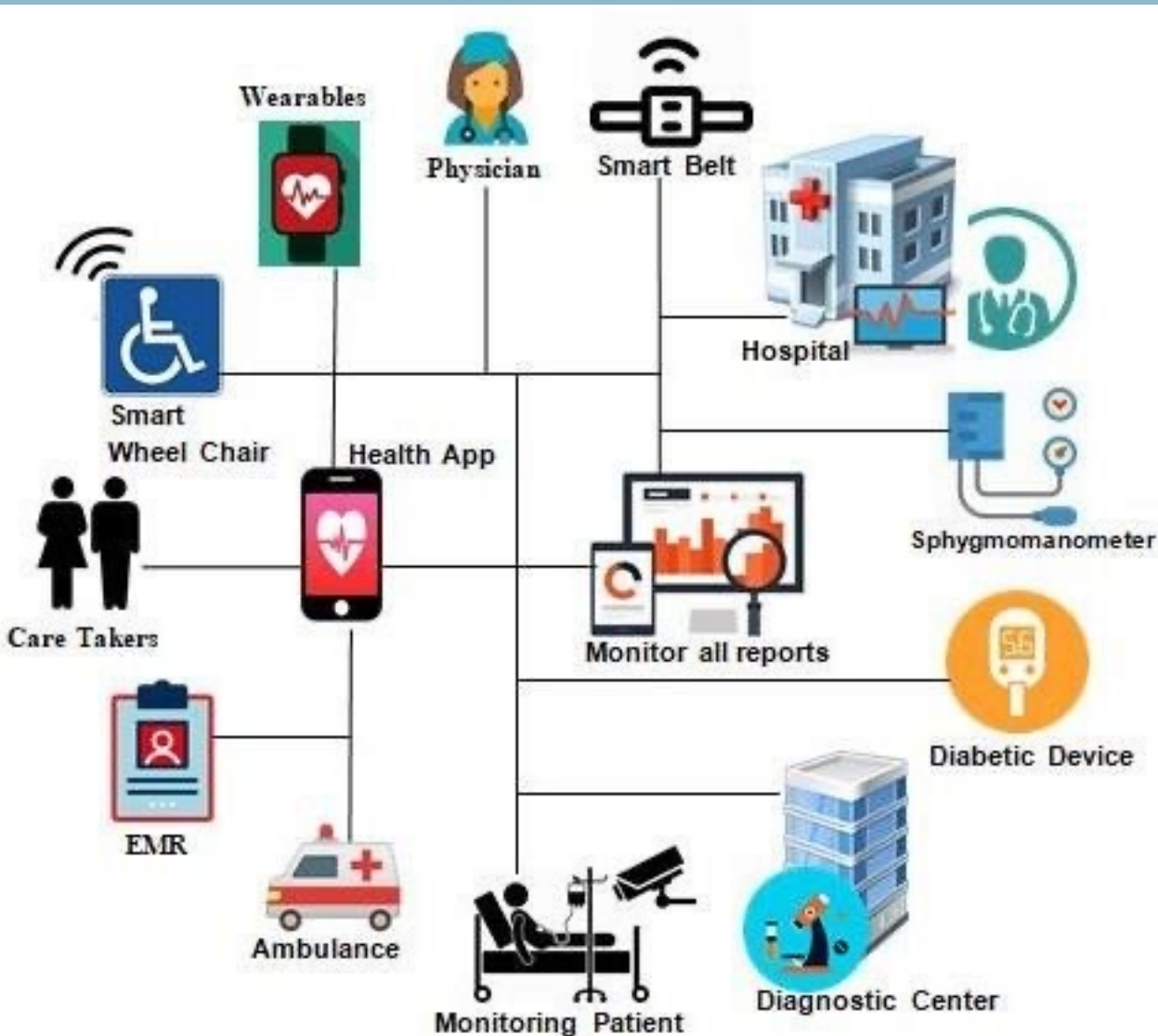

- Large amount of distributed datasets
- Increasing application of Io(M)T & AI
- Minimized human surveillance

Requires Blockchain Technology for:

- Network Trust by Authenticity & Provenance monitoring
- Scalability
- Audit trails
- Automated payments



Statement 1: Clinical Trial Services

“Current offer of professional services (clinical research) from Healthcare institutes hinders valorization of AI in Healthcare and thus the transition.”



Statement 2: AI Training Sandbox

“The lack of access to retrospective (anonymized) clinical patient data – on which AI can be modeled and trained – is slowing down the transition.”



Statement 3: Regulatory landscape

“Current regulatory framework is harmful for startups who want to put innovative AI and predictive algorithms into clinical practice.”





AI for HealthCare

From research and innovation to implementation

Claudine Lamothe (UMCG)
Ronald Hesse (Triade)

De AI-hub Noord-Nederland wordt mede mogelijk gemaakt door de subsidiepartners:



Applications of AI for Health: A trend shift

- From a reactive to a proactive (prevention) healthcare system
- Faster , better, predictive diagnoses
- Personalised treatments
- Predict health progression & treatment impacts at a collective level (cohorts) and at the individual level (personalised care)
- Support better self-management of chronic patients
-

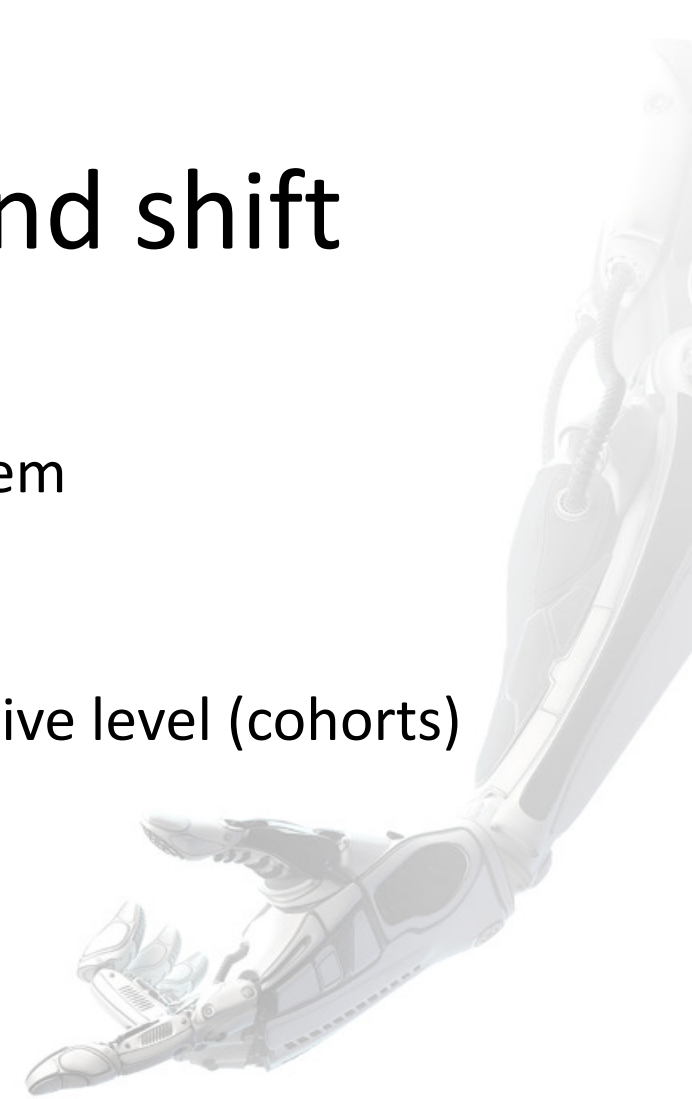

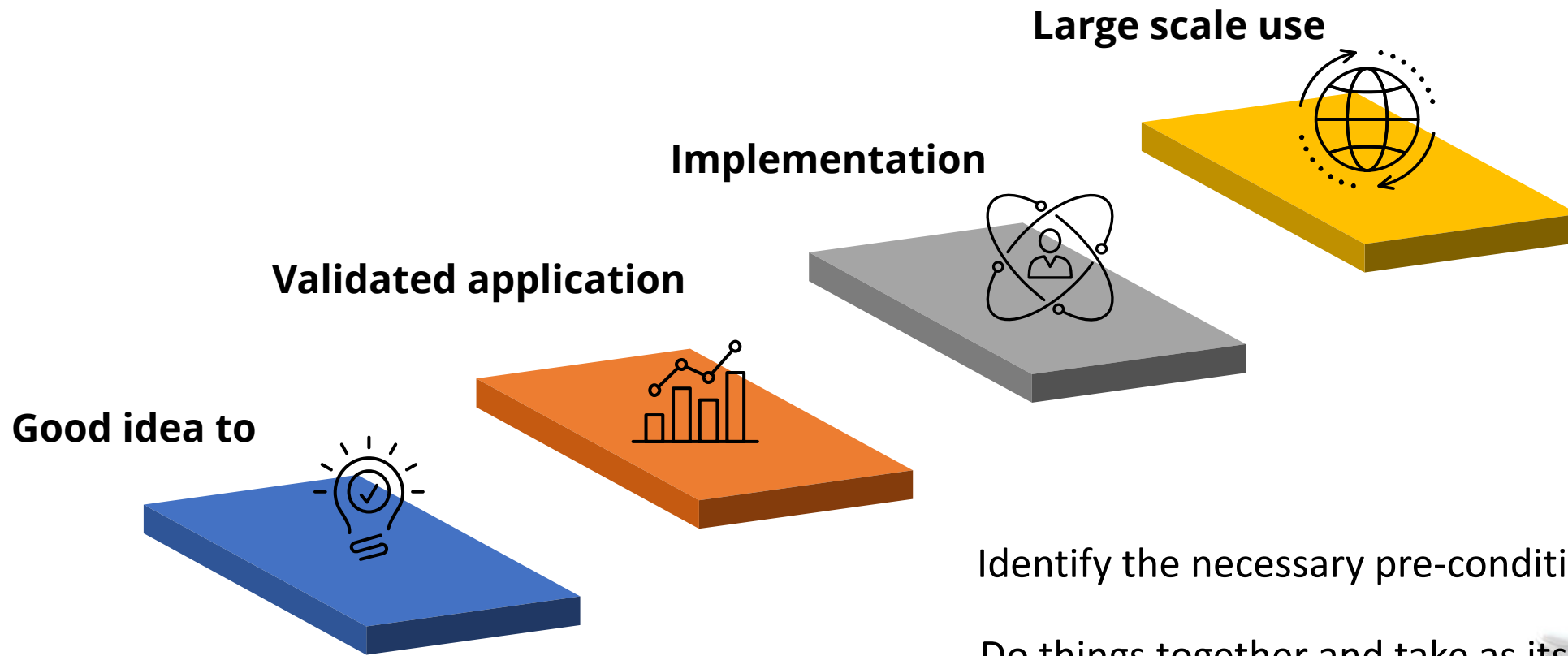

Identify the necessary pre-conditions to implement AI

Do things together and take as its starting point the value AI brings to our society

Emphasis action and impact.

Partner van de NL AIC

Interactive break-out session

- During this interactive break-out session, experiences and challenges towards implementation will be discussed
 - from the perspective of four experienced entrepreneurs
 - Audience
- Two 'use-cases' examples



Healthy living as a service

Realize healthy lifestyle, supported by technology and Artificial Intelligence (AI)-healthy living services

Collaboration across domains, citizens, scientists, technology, healthcare, artists, business and industry

The results will be citizens that have ownership over their health by:

- health, technology and data literacy;
- healthy and involved communities;
- a monitoring system with wearables and nearables;
- motivational feedback and coaching supported by an AI-based Decision Support System



KIC #13948 Leefstijl & Leefomgeving



Predictive Diagnostics



The **Life Cooperative** is a Northern Netherlands-based SME association (coöperatie u.a.) with **45 member-businesses** in the Life Sciences and Health sector, generating over € 500 million turnover with close to 4.500 employees.

Its aim is to facilitate **next generation innovation** by and between member-companies, together with knowledge and health institutes in the region.

www.lifecooperative.nl

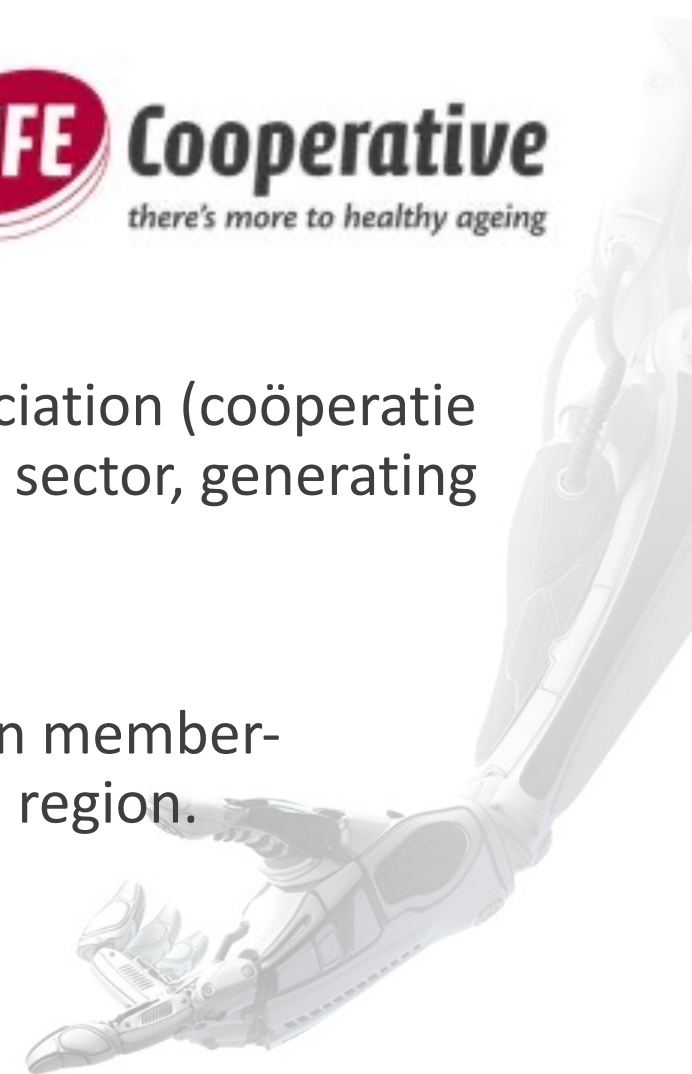

Predictive Diagnostics (2023-2027)

Predictive Diagnostics is a platform for innovation and implementation of AI in Healthcare, serving innovators (TRL 3-8) by providing access to all relevant expertise, facilities, funds and talent in the region. It operates like a **business-run** platform focused on effective, personalized service delivery: from scouting & intake, screening and advice, to business case building and servicing, demonstrations and piloting, and finally (scale-up) investor readiness and intro.



Scout 100+ leads



accept 40 into the program



generate 10+ investable BC's

To get there, the platform needs to build competences and track-record, as well as a comprehensive infrastructure (network, collaborations and additional services and facilities).

Total budget will be around **€ 8M**



Chandler Hatton
CTO



ZIUS.
visual intelligence



Real-world applications for AI & computer vision

Forensic Investigations



Pharmacy Automation



Medical Imaging

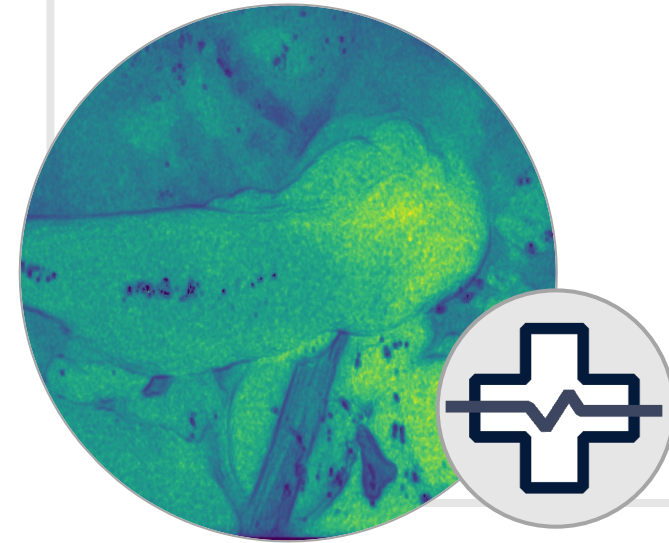



ZiuZ Forensic Investigations

VizX2

2nd generation,
first product
launch 2006



Market leader in products and services that **analyze huge amounts of visual data** to fight sexual abuse of children, used in 50+ countries worldwide

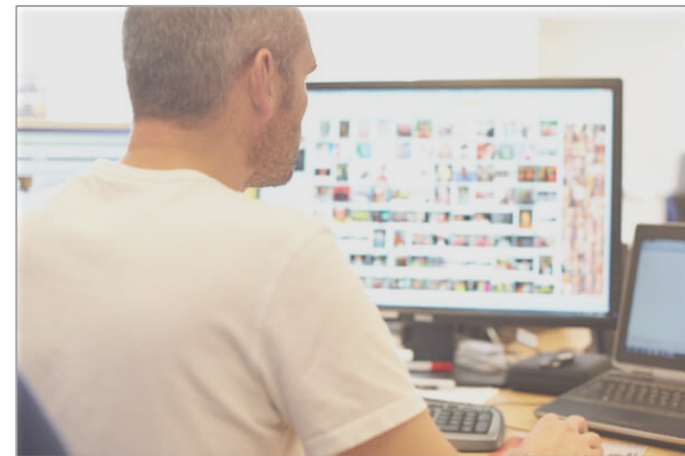
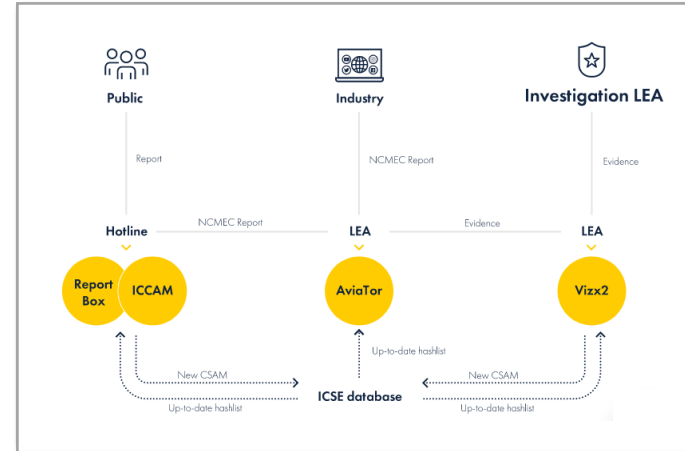



ZiuZ Pharmacy Automation

ApolloZ

3rd generation,
first product
launch 2009

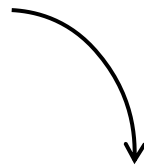

Market leader in
automated visual checking
of medicine pouches,
checking **12 million pouches**
in 17 countries each day





ZiuZ Medical Imaging & LIMIS

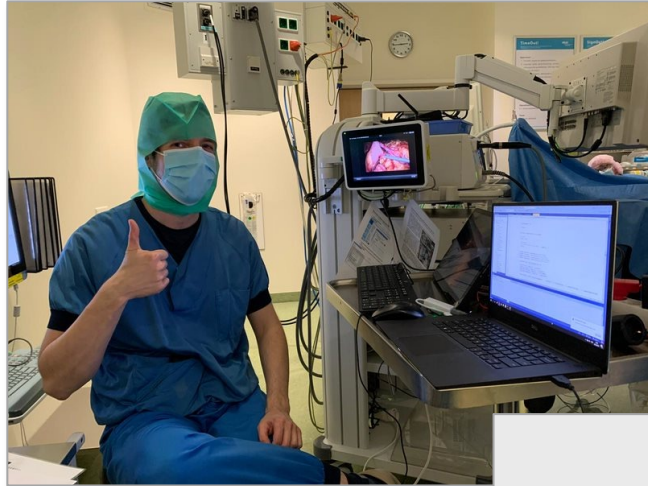

A medical device that offers surgeons a **real-time** heatmap of microvascular **blood flow** using **laser speckle contrast imaging**

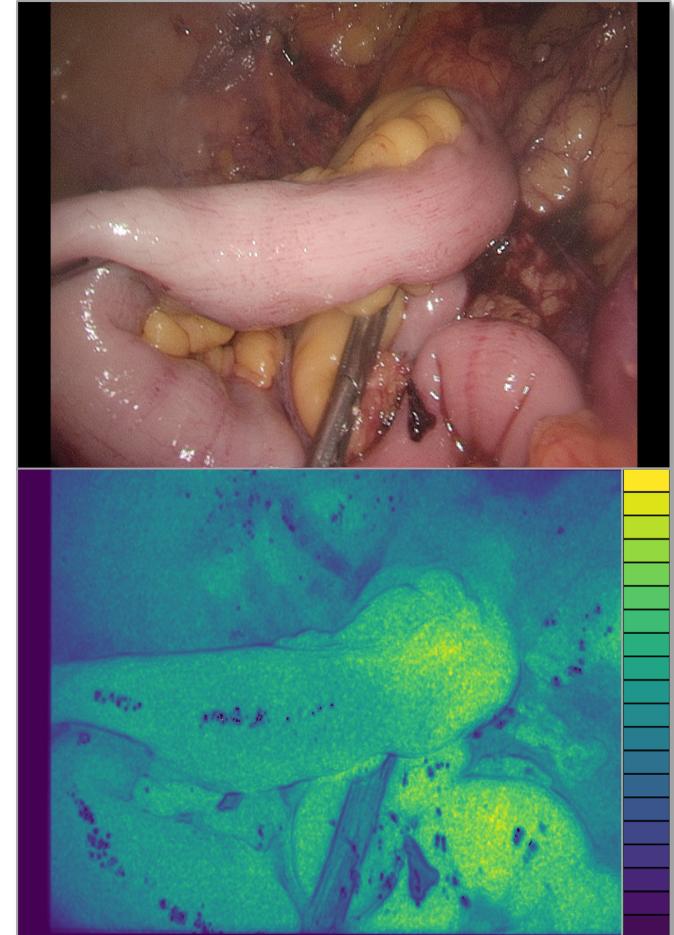

PerfusiX-Imaging

First product
launch 2023



ALESSANDRO GRILLINI, PhD, CEO/CTO

- Background in Computer Science, Psychophysics, Computational Neuroscience
- Solo founded Reperio Medtech in 2020
- CEO/CTO, team of 6
- From “idea in the lab” to “product on the market”



REPERIO MEDTECH

Objectify neuro-visual diagnostics with Eye-Tracking and Deep Learning

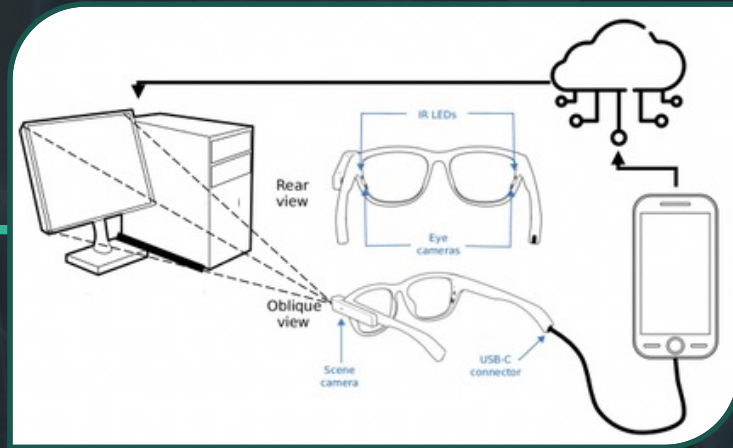
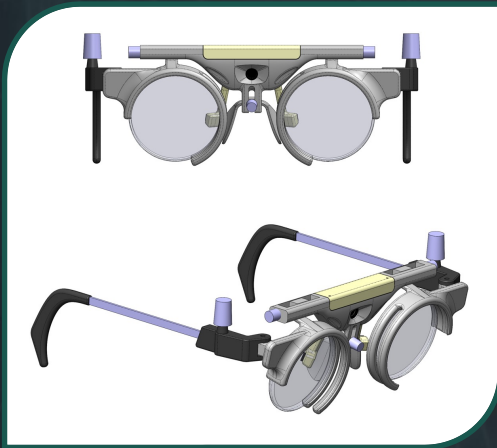

AI

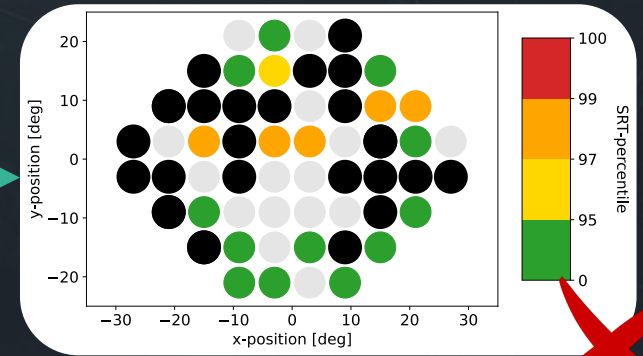
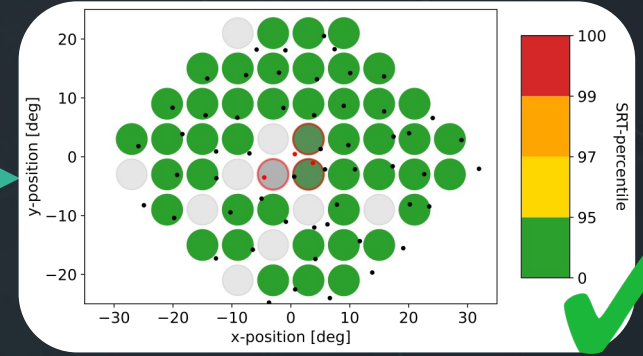

Accurate & Objective



Patient-Friendly & Portable



80% Faster than current methods

Algorithm development

CE certification

1

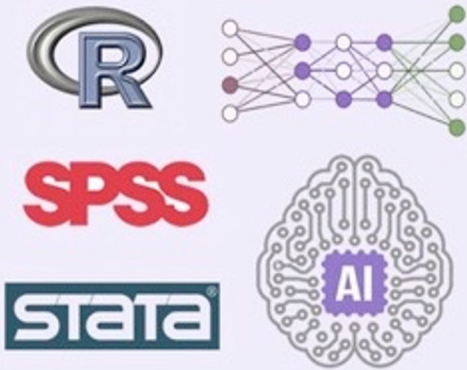

EVIDENCIO



3



$$P = \frac{e^{(\beta + \alpha_1 X_1 + \dots + \alpha_n X_n)}}{1 + e^{(\beta + \alpha_1 X_1 + \dots + \alpha_n X_n)}}$$

Algorithm validation

Algorithm integration

2



4

More info? Please send an e-mail to r.g.pleijhuis@evidencio.com or visit www.evidencio.com

Standardized algorithm creation

Evidencio offers tools for researchers to create functional prediction algorithms in a standardized manner.

Settings Variables Formula segments RScript

Calculation method

Linear model
Logistic regression
Cox regression
Custom model
RScript
External API

Input type

Custom variables

Calculation (More info)
Insert your own R script

Model variable type ⓘ

Standard model	UMLS model
----------------	-------------------

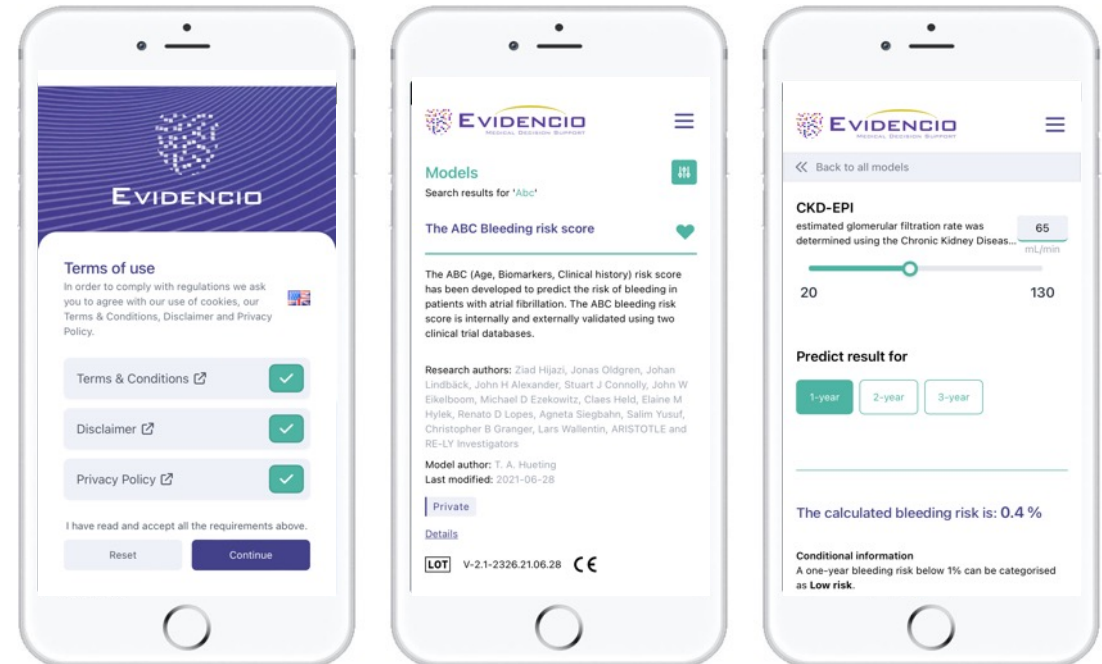
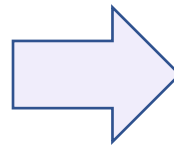

Compliance with European law (MDR)

Evidencio enables cost-effective and time-efficient CE-certification of (pooled) prediction algorithms through:

- Standardization
- Established QMS
- Reuse of platform components



EUROPEAN
COMMISSION



Traditional Healthcare: co-location of patient, doctor, diagnostic procedures and data

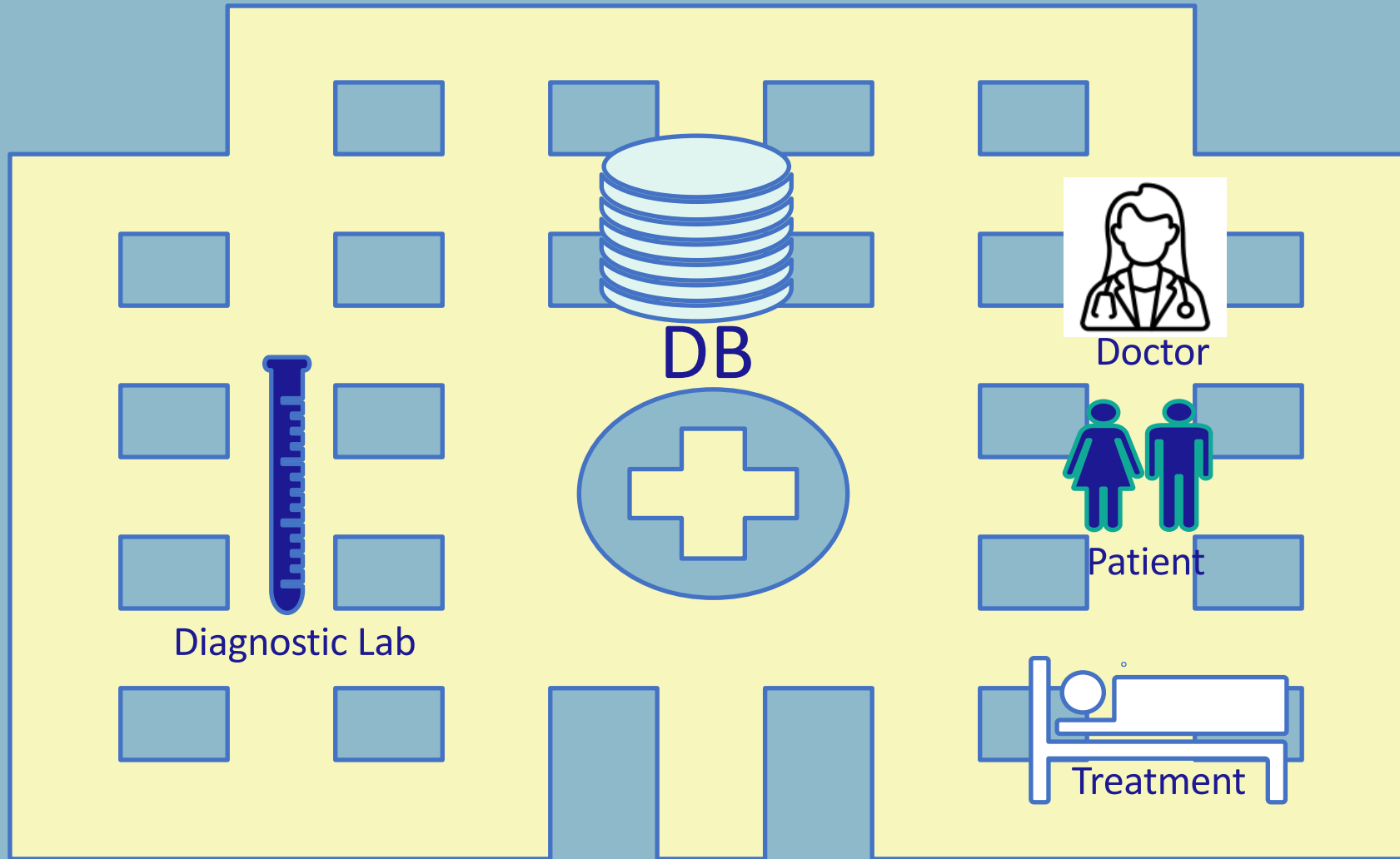

The rise of Distributed Healthcare (DH) including AI:

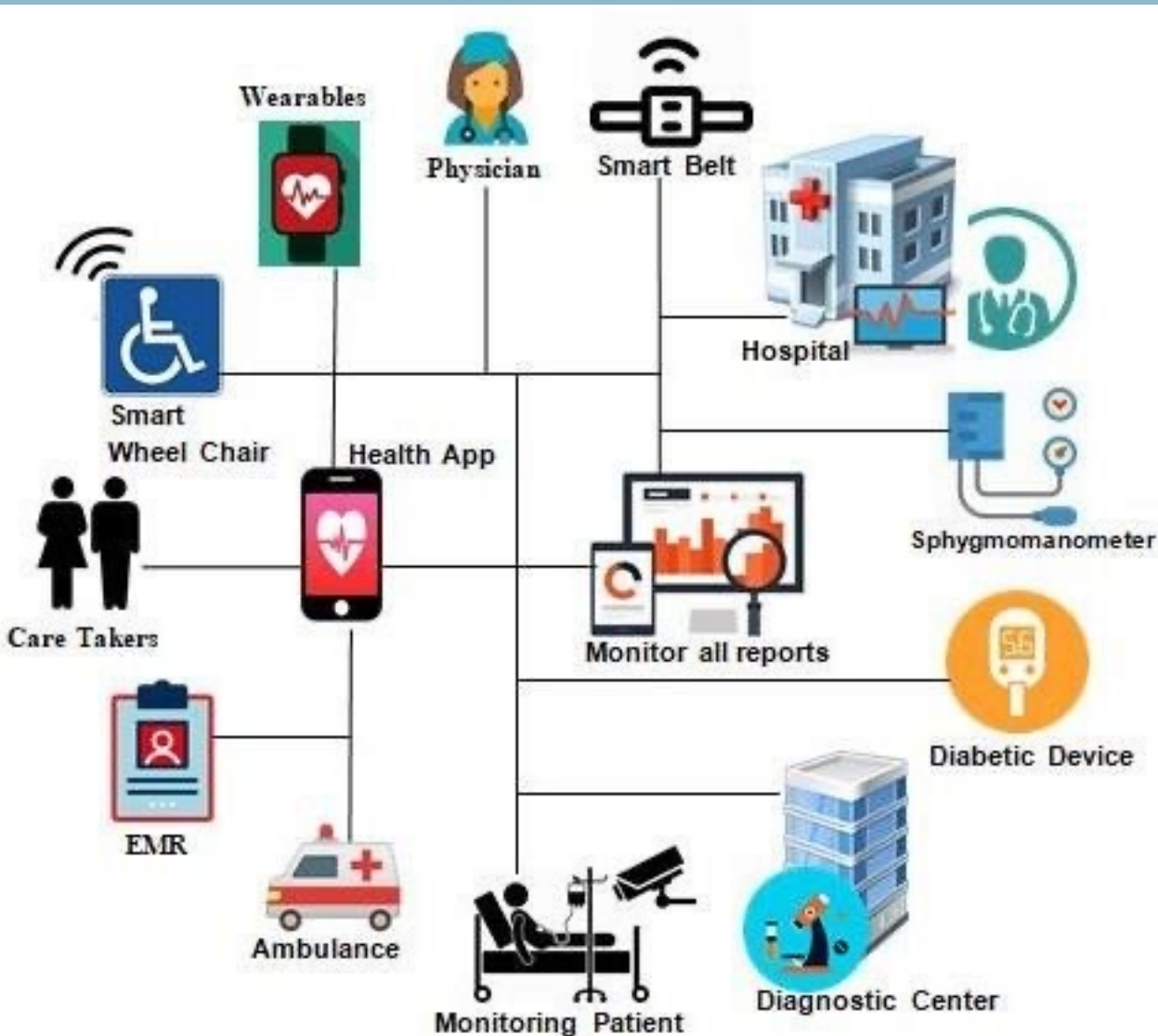

- Large amount of distributed datasets
- Increasing application of Io(M)T & AI
- Minimized human surveillance

Requires Blockchain Technology for:

- Network Trust by Authenticity & Provenance monitoring
- Scalability
- Audit trails
- Automated payments



Statement 1: Clinical Trial Services

“Current offer of professional services (clinical research) from Healthcare institutes hinders valorization of AI in Healthcare and thus the transition.”



Statement 2: AI Training Sandbox

“The lack of access to retrospective (anonymized) clinical patient data – on which AI can be modeled and trained – is slowing down the transition.”



Statement 3: Regulatory landscape

“Current regulatory framework is harmful for startups who want to put innovative AI and predictive algorithms into clinical practice.”

